



DEGLAS® Corrugated Sheet Installation Instructions

DEGLAS corrugated sheets are installed with an overlap, whenever the opening is greater than the width of the sheet (ie., approx. 41" (1045 mm) for the DEGLAS IMPACT WP3 76/18) or the length is greater than 13 feet (approx. 4000 mm). To determine the correct number of sheets required for a specific project, keep in mind that the coverage (b) is less than the actual width (B) of the sheet. The lateral overlap (s) is about 2.83" (72 mm). Similarly the horizontal overlap (h) is to be considered for openings longer than the delivered sheet length.

The horizontal overlap should be about 7.75" (200 mm) for roof slopes less than 17° (3.5:12 pitch) and about 6" (150 mm) for roof slopes greater than 17°.

For vertical applications, the horizontal overlap should be about 4" (100 mm).

The maximum installed sheet length should not be more than 13 feet (4000 mm).

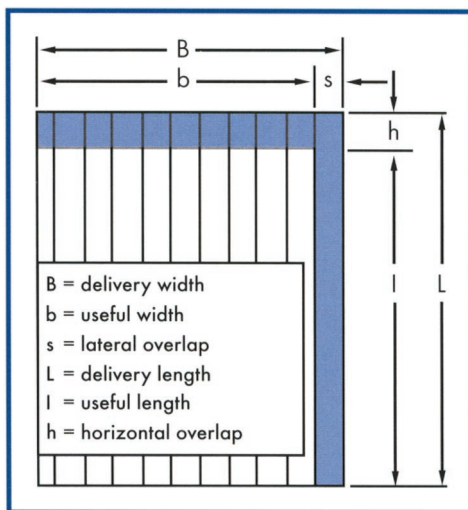

Fig. 1: Overlap of corrugated sheets.

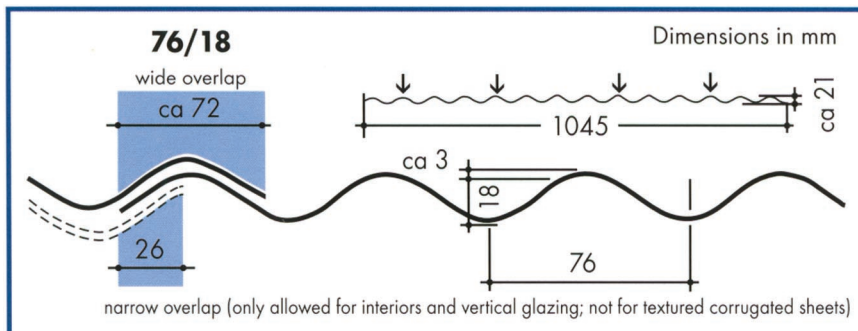

Fig. 2: Cross Section of DEGLAS WP 76/18 corrugated sheet. The downward pointing arrow (↓) depicts the fastening points (at the crest of corrugation #2+5+9+12).

SUPPORT SPACING:

DEGLAS WP corrugated sheets are installed on structurally sound support members that are positioned at right angles to the direction of slope or water flow. These purlins or cross members are spaced (A) as per the chart (Fig. 3) below to correspond to the design snow and/or wind load pressures.

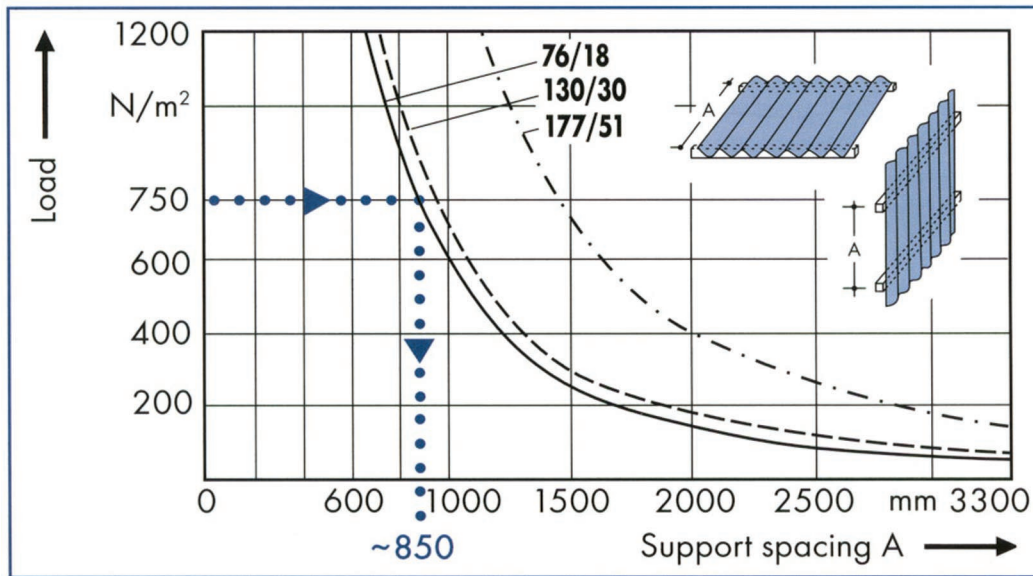

Fig. 3: Recommended Support Spacing for DEGLAS Corrugated Sheets.

Example: for a load of 750 N/m² (15.7 psf) the recommended support spacing is about 850 mm (about 33") for the DEGLAS WP 76/18 corrugated sheet.

ROOF PITCH:

DEGLAS WP corrugated sheets are to be installed at a roof pitch of at least 5° (1:12 pitch). The steeper the slope, the better the self-cleaning effect during rainfall.

AVOIDING HEAT BUILDUP:

The coating (paint or stain, etc.) applied to the supporting structure must be thoroughly dry before the sheets are installed.

When installing the DEGLAS corrugated sheets, it is recommended that the top surfaces of the structural members be either a light-color or have a reflective coating applied to them. Coating the top surface of the members with a weatherable white emulsion paint will avoid harmful heat buildup on that surface due to sunlight.

INSTALLATION:

Installing DEGLAS Corrugated Sheets:

Corrugated sheets are always installed so as to overlap, similar to roof tiles. The outer lateral overlap should be to the leeward side (away from the prevailing wind direction) when placing the sheets side by side. When placing the sheets end to end, the upper sheet overlaps the lower sheet. This applies to either a sloped roof or vertical wall application.

DEGLAS corrugated sheets may be walked over, but only after boards capable of supporting a man's weight are safely in place. Ladders and scaffolding may be necessary depending on the slope of the roof and height from the ground. Do NOT walk directly on the sheet, both from a safety and a breakage or damage aspect. The sheets are slippery.

Surface-textured sheets (prismatic, honeycomb, etc) are to be installed with the textured side facing downward. The DEGLAS WP HEATSTOP corrugated sheets are always installed with the solar heat-reflecting matte finish facing upwards.

Maximum Installed Lengths:

DEGLAS corrugated sheets should be installed in lengths no greater than 13 feet (4000 mm). Acrylic sheets expand and contract due to thermal fluctuations. Point fastening the corrugated sheet restricts that movement, so it is necessary to limit the installed sheet length to no more than 13 feet (4000 mm). For greater glazed heights or roof slopes, refer to the overlap recommendations (Fig. 1 and Fig. 2 above and Fig. 4 below) and details in this booklet.

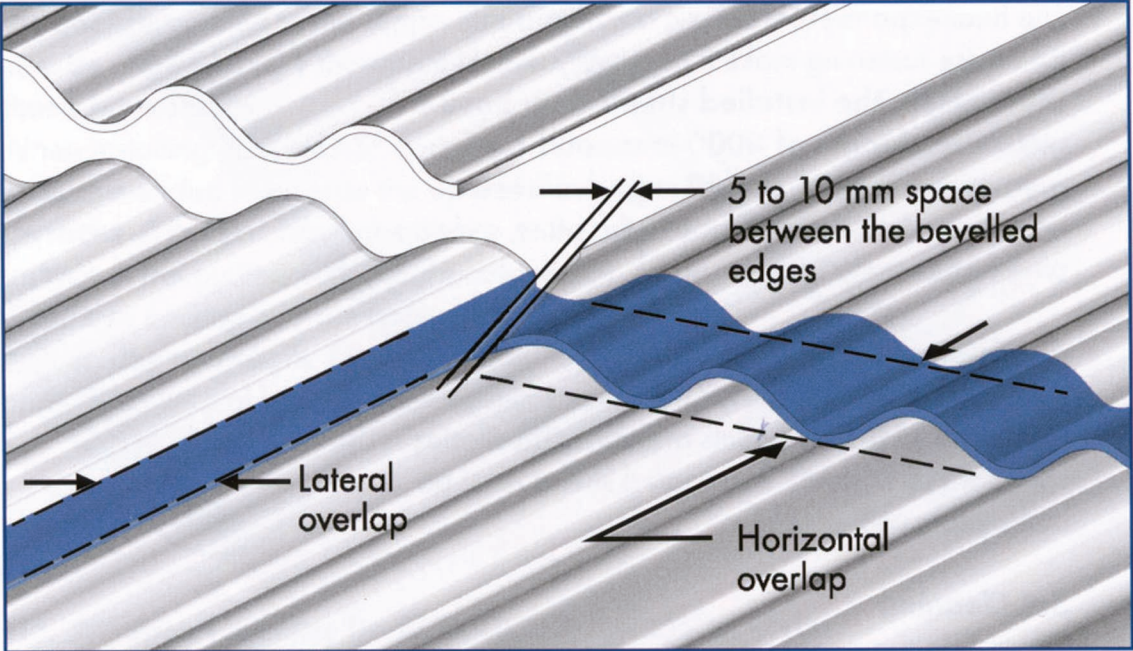

Fig. 4: Lateral and Horizontal Overlap Details

COMPATIBILITY:

All sealants, gaskets, weatherseal washers, cleaning agents and other materials coming in contact with the corrugated sheet must be compatible with acrylic. Contact your distributor or us for recommendations.

CLEANING:The self-cleaning effect from rain will wash off normal accumulations of dust and or dirt. There is little need to clean the sheets installed in a vertical wall or on an adequately sloped roof. Should cleaning be required, rinse the sheet thoroughly with a garden hose or wash with a solution of mild soap or detergent and lukewarm water. Do not use cleaning sprays,

kitchen scouring compounds or solvents such as acetone, benzene, alcohol, carbon tetrachloride, or lacquer thinners. These can scratch the sheet's surface and/or weaken the sheet causing small surface cracks called "crazing".

CUTTING TO SIZE:

DEGLAS corrugated sheets are best cut to size using high-speed portable circular saws with hollow ground, multi-tooth carbide-tipped saw blades. A 7 to 8" diameter saw blade should have 40 to 60 teeth, commonly referred to as TCB (triple chip blade). Tooth design should have a clearance angle of between 10 to 15° and a rake angle of 0 to 5°.

Do not use abrasive disks or saw blades with offset teeth.

The sheet should be firmly clamped to avoid vibration. Use a stop or guide to get a clean, straight cut and to prevent the saw blade from jamming and either melting or chipping the sheet.

Corner Cutting: Fig. 4 depicts how the corners of the corrugated sheets have to be cut back (beveled) when lateral and horizontal overlap situations arise.

DRILLING:

DEGLAS corrugated sheets that are to be point fastened need to be pre-drilled with the proper tool. A stepped drill bit (fig. 5a) or a conical bit (fig. 5b) is recommended. The hole should be 0.50" (13 mm) in diameter for a #14 [about 1/8" dia. (6.3 mm)] wood screw. Corrugated sheets that overlap horizontally are drilled together. Lift the top sheet up and enlarge the lower sheet hole another 1/16" to 1/8" (2 to 3 mm), to accommodate expansion differences.

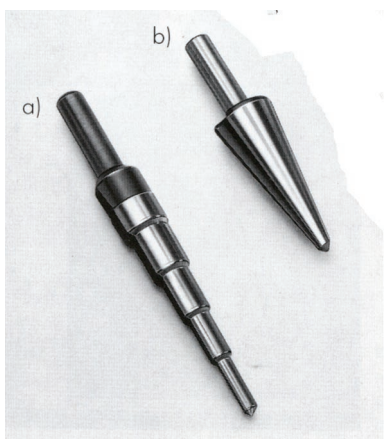

Fig. 5 Drilling bits for corrugated sheet

FASTENING:

Fastening Recommendations:

The DEGLAS WP corrugated sheets are point fastened to the supporting structure using the appropriate fasteners. On roof applications, the fastener location is always on the crest of the corrugation (Fig. 6a & 6b). The DEGLAS WP sheet is very rigid, thus no shims are needed beneath the crest of the corrugation. Competitive corrugated sheets are not as rigid or thick and must have stand-off shims or spacers placed between the sheet and the support member at the fastening point.

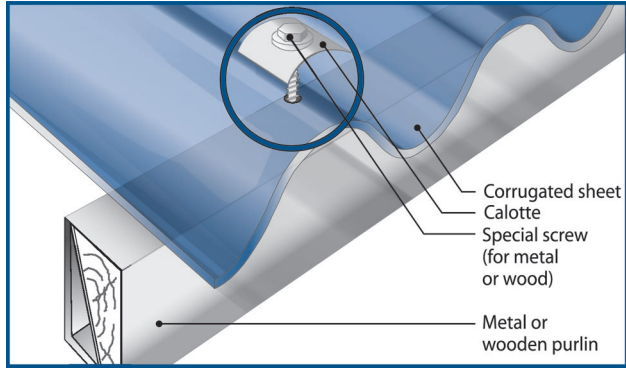

Fig. 6a Point Fastening of Corrugated Sheet to Cross Member

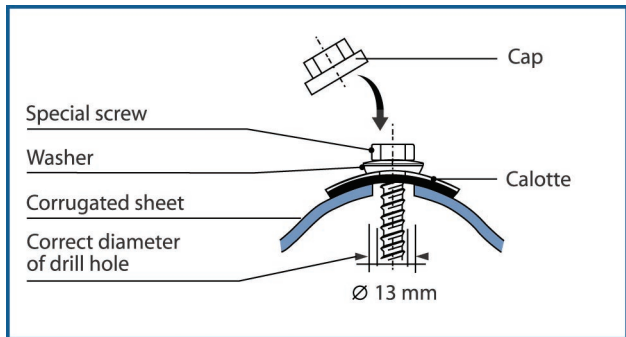

Fig. 6b Detail of curved washer (calotte), screw and optional plastic cover cap

FASTENERS:

The most common way to fasten corrugated sheets is to drive in a screw into the center of the upper side of the support purlin. Screws for wood (#14) or metal (#14 self-drilling and tapping) with sealing bonded washers are commercially available. The curved metal washer (calotte) with bonded sealing washer is placed between the screw washer and the corrugated sheet (Fig. 6b). It seals the drill hole below and evenly distributes the screw pressure. Colored plastic caps are available to cover the head of the screw, providing weather protection and improving the general appearance when viewed from above.

Fire Precautions: ACRYLITE SDP sheets are produced from molding compounds which are combustible thermoplastics. Precautions used to protect combustibles from flames and high heat sources should also be observed with these materials. SDP sheets usually burn rapidly to completion if not extinguished. The products of combustion, if sufficient air is present, are carbon dioxide and water. However, in many fires, sufficient air will not be available and toxic carbon monoxide will be formed, as it will from other combustible materials. We urge good judgment in the end use of these versatile materials and recommend that building codes be followed carefully to assure they have been used properly. Access panels may be required for evacuation and venting of rooms glazed with SDP sheets. SDP sheets burn more rapidly than their solid counterparts. Non-combustible end caps must be used to prevent flame from contacting the open ends of the sheet.

IMPORTANT NOTICE: The information and statements herein are believed to be reliable but are not to be construed as a warranty or representation for which we assume legal responsibility. Users should undertake sufficient verification and testing to determine the suitability for their own particular purpose of any information or products referred to herein. NO WARRANTY OF FITNESS FOR A PARTICULAR PURPOSE IS MADE. Nothing herein is to be taken as permission, inducement or recommendation to practice any patented invention without a licence.